

New builds roller shutter overview.



Overview of Alulux's entire range of **aluminium profiles**. We have the ideal roller shutter profiles for every possible installation situation.

CD 135



Aluminium profile that can be wound extremely tight

Technical data:

Nennstärke	8,85 mm
Surface area	35,1 mm
Max. area	6,0 m ²
No. of profiles for 1 m height	28,5

Available colours: 01, 02, 03, 04, 08, 11, 54

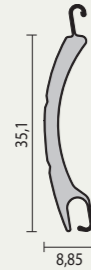

CD 137



Slim alu. profile, small coil diameter

Technical data:

Nominal thickness	8,5 mm
Surface area	37,0 mm
Max. area	7,0 m ²
No. of profiles for 1 m height	27

Avail. col.: 01, 02, 03, 04, 06, 07, 08, 09, 11, 12, 16, 17, 18, 19, 32, 35, 39, 44, 45, 46, 54, 80

CD 137 ultra in 01, 04, 35

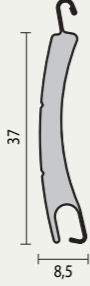

CD 150



Strong aluminium profile for large dimensions

Technical data:

Nominal thickness	8,7 mm
Surface area	40,0 mm
Max. area	8,5 m ²
No. of profiles for 1 m height	25

Available colours: 01, 02, 03, 04, 07, 08, 09, 11, 12, 28, 31, 32, 51, 54

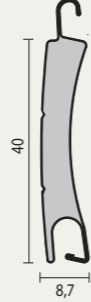

CD 150 ultra



Strong aluminium profile with ultra-hard foam core

Technical data:

Nominal thickness	8,7 mm
Surface area	40,0 mm
Max. area	10,5 m ²
No. of profiles for 1 m height	25

Available colours: 01, 02, 03, 04, 11, 54

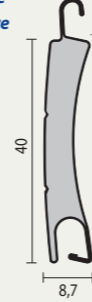

CD 540



Roll formed protection: The galvanized steel roller shutter profile

Technical data:

Nominal thickness	8,7 mm
Surface area	40,0 mm
Max. area	10,0 m ²
No. of profiles for 1 m height	25

Available colours: 01, 02, 03, 11

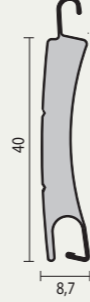

CD 40



A strong aluminium roller shutter profile for maximum protection and available in a wide range of colours

Technical data:

Nominal thickness	8,7 mm
Surface area	40,0 mm
Max. area	10,0 m ²
No. of profiles for 1 m height	25

Available colours: subject to RAL card



▲ Top row – small profiles, bottom row – standard profiles ▼

Image scale 1:0.43, technical drawings 1:74

CD 400



Aluminium profile with an extremely small coil diameter

Technical data:

Nominal thickness	13,5 mm
Surface area	51,0 mm
Max. area	8,0 m ²
No. of profiles for 1 m height	19,6

Available colours: 01, 02, 03, 04, 06, 08, 11, 39, 54, 80

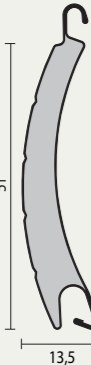

CD 300



Aluminium profile with small coil diameter for great heights

Technical data:

Nominal thickness	14,0 mm
Surface area	55,0 mm
Max. area	10,0 m ²
No. of profiles for 1 m height	18

Available colours: 01, 02, 03, 04, 06, 07, 08, 09, 11, 12, 54

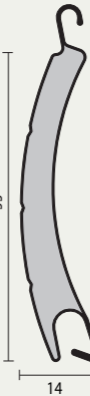

CD 200



The classical aluminium roller shutter profile for use in new builds

Technical data:

Nominal thickness	14,0 mm
Surface area	55,0 mm
Max. area	12,0 m ²
No. of profiles for 1 m height	18

Available colours: 01, 02, 03, 04, 08, 11, 32, 54



CD 200 ultra



The classical aluminium profile with ultra-hard foam core

Technical data:

Nominal thickness	14,0 mm
Surface area	55,0 mm
Max. area	12,0 m ²
No. of profiles for 1 m height	18

Available colours: 01, 02, 03, 04, 11, 54



CD 550



Security steel profile with foiled surface

Technical data:

Nominal thickness	14,0 mm
Surface area	55,0 mm
Max. area	12,0 m ²
No. of profiles for 1 m height	18

Available colours: 01, 02, 03, 11

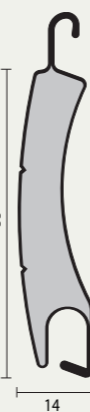

CD 70



Burglary protection! Extra safe aluminium profile with VDS certificate

Technical data:

Nominal thickness	13,2 mm
Surface area	54,0 mm
Max. area	15 m ²
No. of profiles for 1 m height	18

Available colours: subject to RAL card



We, as roller shutter specialists are convinced by the quality of Alulux aluminium roller shutters. Read below, why...

MADE IN GERMANY

ALULUX®
Experience the best quality!

Your Alulux specialist

Alulux Beckhoff GmbH & Co. KG
Messingstraße 16 · D-33415 Verl
Phone +49/52 46/9 65-0
Fax +49/52 46/9 65-2 90
E-Mail info@alulux.de



Some of the many reasons why **aluminium roller shutters** are the best choice!



Why does Alulux offer 13 different types of aluminium roller shutter profiles for new builds and different roller shutter boxes?

13 different types of Alulux roller shutters – all MADE IN GERMANY. Of course you are wondering whether that huge choice is really necessary. Aren't all roller shutters much the same? Well, experience has shown that there are great differences, for example, between the type of roller shutters needed for new builds and those for renovated properties. By offering such a large range of roller shutters, Alulux ensures that each of its customers can be sure to find the right shutter for their home! There are various criteria that can be used to determine the suitable shutter profile:

- ✓ Space! How much space is available for fitting the roller shutter box?
- ✓ Security! Which degree of security is required from my roller shutter?
- ✓ Durability! Do you prefer a solid roller shutter or something more lightweight and ornamental?
- ✓ Colour! Are you looking for something unusual or are you happy with the standard colour programme?

✓ Material! Roll formed, extruded, aluminium, steel?
In new builds and energy-efficient homes, you have often only 17 cm space available for your roller shutter box, our extremely tight-winding roller shutter profiles CD 135 and CD 137 will be the ideal choice for you! On the other hand, if you have plenty of space for your roller shutter box and want to fit your Victorian villa with, lets say, moss-green roller shutters, our roller shutter profile CD 300 will be just what you need. However, if your are seeking after increased security, our steel shutter profile CD 550 will meet your requirements perfectly. Or maybe you prefer our CD 200 ultra profile, with its ultra-hard foam core. If you are into colours and want to have as large a choice as possible, we highly recommend profiles CD 40 and CD 70, available in all RAL colours. Alulux's large range of roller shutter profiles is sure to meet every requirement! Just ask you Alulux specialist!

CD 135 138 profiles correspond to a roller shutter height of 480 cm and can be coiled into a diameter of 23 cm.



CD 200 40 profiles correspond to a roller shutter height of 220 cm and can be coiled into a diameter of 23 cm.



- Aluminium is the ideal material for use in components that are daily exposed to the weather and that have to be light as well as extremely strong.
- Aluminium is corrosion-resistant and the surfaces of our aluminium profiles are furthermore coated with a thick layer of stove enamel.

Functionally reliable:
✓ Benefit: Aluminium is extremely durable and weather resistant, as well as being very light. Aluminium roller shutters are always easy to operate!



There are just things that should be better made of aluminium!

However, aluminium roller shutters provide many more advantages:

- CFC-free foam:**
✓ Benefit: silent run, resonance-free, torsion-proof
- Grooves in profile:**
✓ Benefit: Increase stability and look great
- Colour and light-fast:**
✓ Benefit: No recoating required, brilliant colours - guaranteed for decades

Best equipment of our roller shutters, of course.

Only high-quality operation elements are used in production. The quality components are invisible from the outside and offer highest reliability of the product.
High-quality ball bearings.The bearing of the roller shutter shaft is in high-quality metal ball bearings. **Plastic inlet funnel.**The roller shutter is guided smoothly and material-saving through plastic inlet funnels. **Profile**

locking device.The roller shutter is secured against side sliding by high-quality special side lockings. **Steel retainer spring.**The steel retainer springs make it difficult to push up the roller shutter from the outside. **Aluminium end slat with sealing profile** An extruded end slat with sealing profile prevents from freezing on the window sill and enables the roller shutter to touch down with low noise.