

Measurements

Clear width in mm	
Clear height in mm	
Unit width in mm	
Unit height in mm	
_____ mm	
Stop for deflection unit	Please transfer all measurements to the order form, page 3.

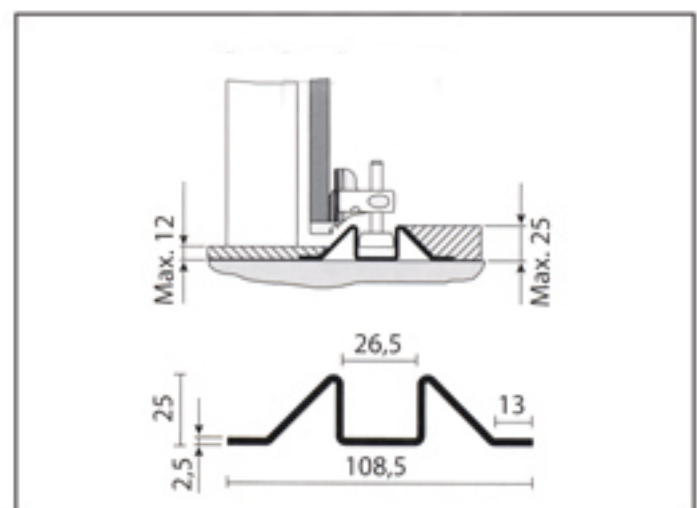

Wall Installation Types

Ideal situation
"perpendicular wall"

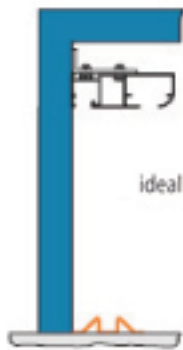

ideal

Situation 1
"wall slopes inwards"

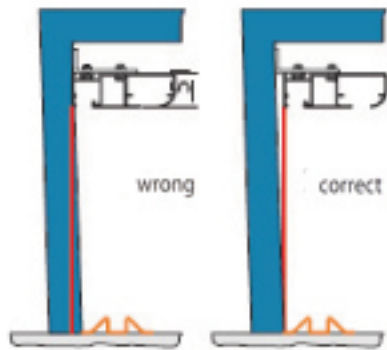

wrong

correct

Situation 2
"wall slopes outwards"

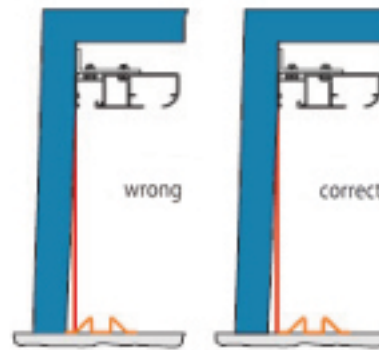

wrong

correct

Situation 3
"wall bulges"

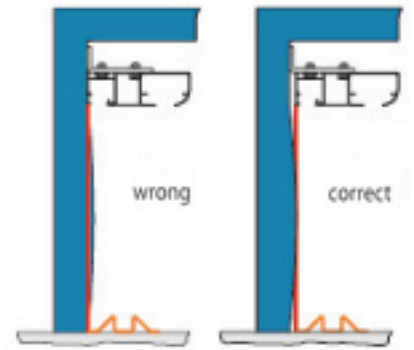

wrong

correct

It is essentially that the two guide channels are perfectly aligned (such that a line drawn between the two is perpendicular to the floor).

Clear width, control of the turn radius

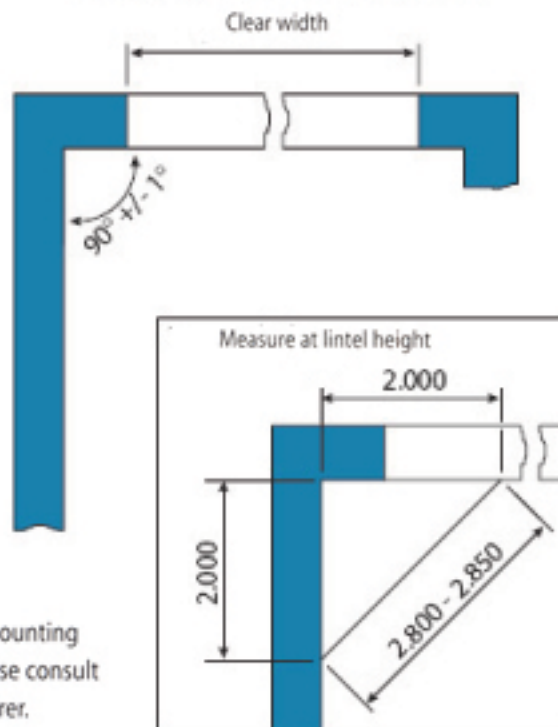

For different mounting situations, please consult the manufacturer.

Floor rails

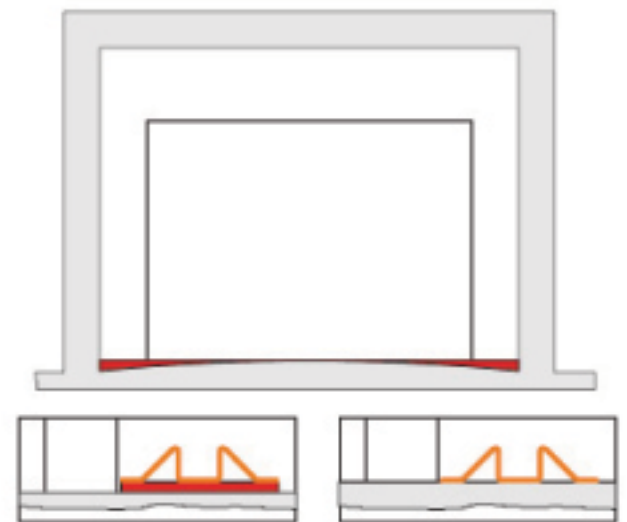

The mounting support for the floor rails must be straight. If necessary, the floor rails must be supported underneath with a lining or the floor must be leveled out.

Clear height, control of the floor incline

